

.1 PLANOS
DRAWINGS

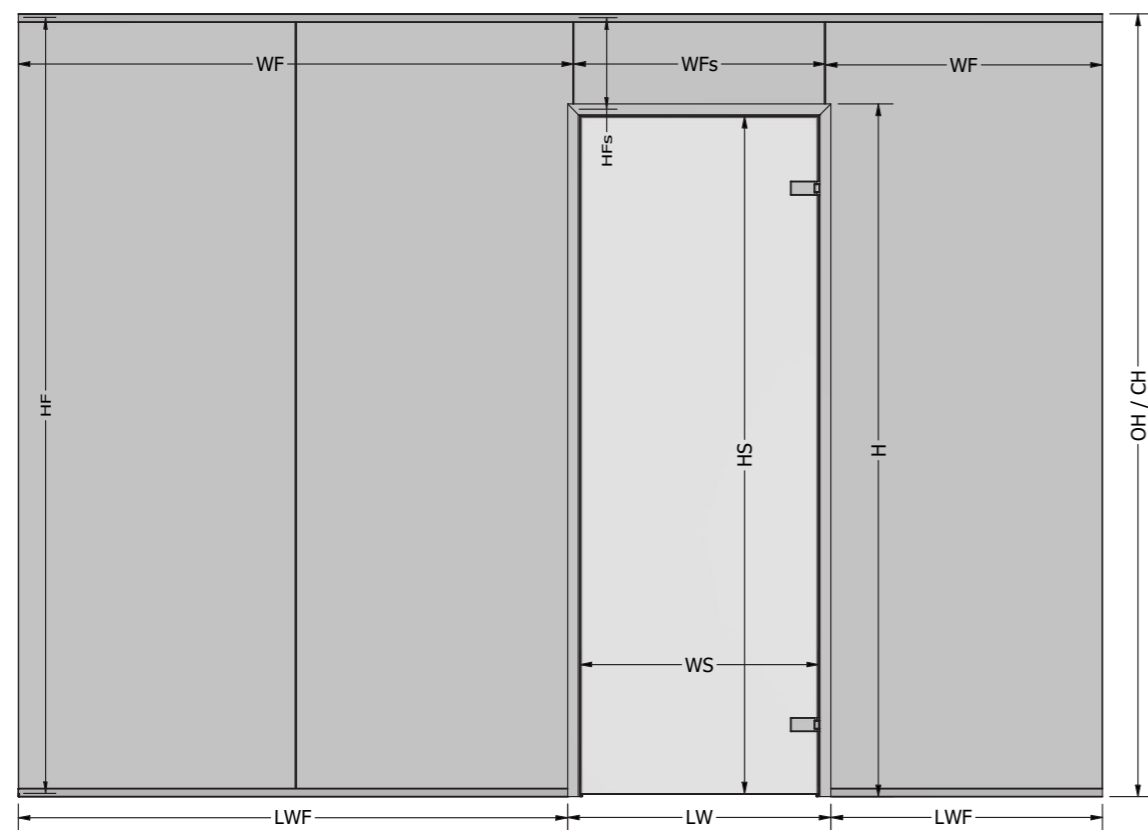

.2 MONTAJE
ASSEMBLY

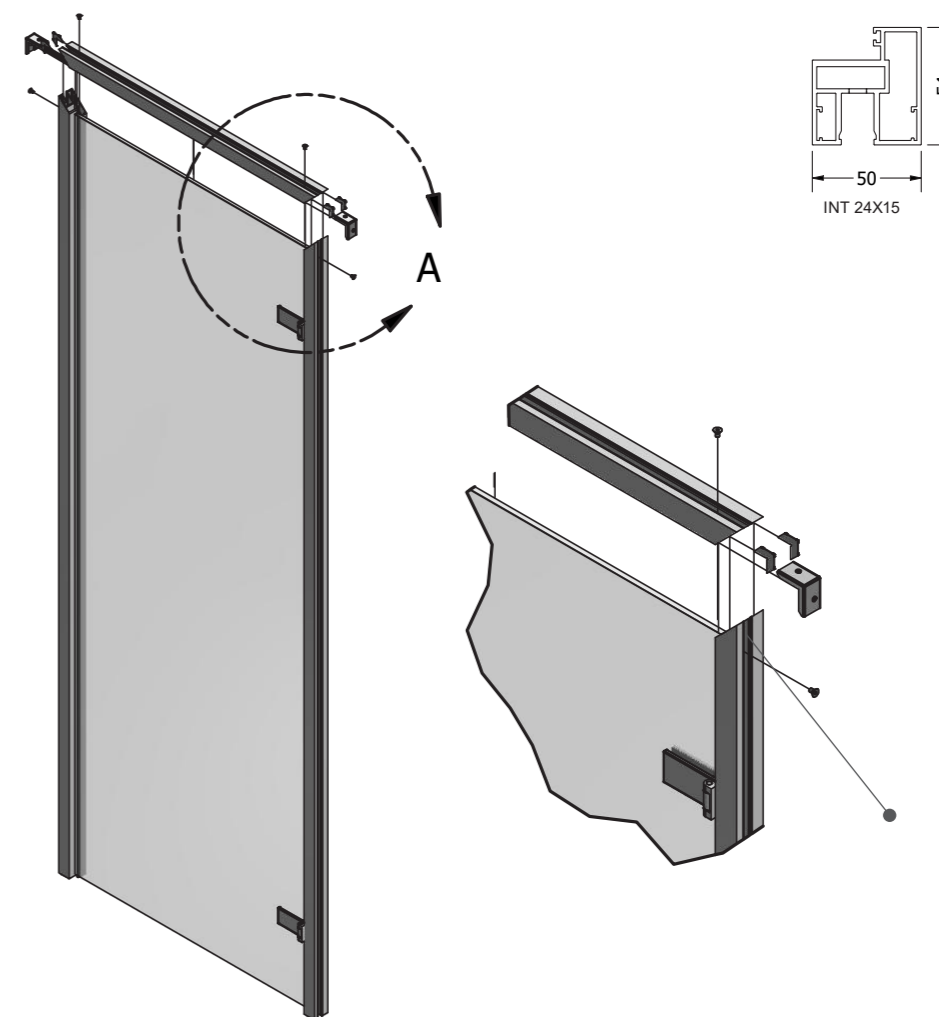

LEYENDA		
OH / CH	ALTURA ÚTIL OBRA	
H	ALTURA DEL MARCO DE LA PUERTA	
LW	ANCHURA DEL MARCO DE LA PUERTA	
HS	ALTURA HOJA MOBIL	H-54
WS	ANCHURA HOJA MOBIL	LW-88
HFS	ALTURA FIJO SUPERIOR	$((OH/CH)-H)+7$
WFS	ANCHURA FIJO SUPERIOR	LW-44
HF	ALTURA FIJOS LATERALES	$(OH/CH) - 25$
WF	ANCHURA FIJOS LATERALES	LWF+20

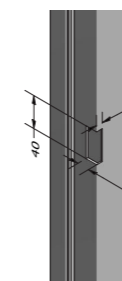

Detalle de fresado marco

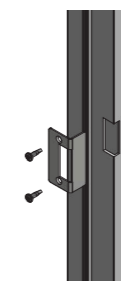

Detalle de la colocación de cerradero

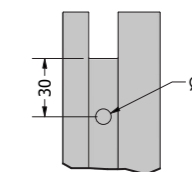

Detalle mecanizado marco para escuadra

.1 PLANOS
DRAWINGS

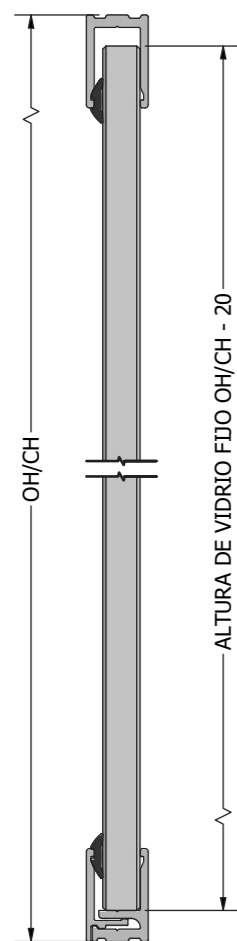

40.003073.00		12MM Ó 6+6
40.005127.00		12MM Ó 6+6
40.003075.00		10MM Ó 5+5
40.005129.00		10MM Ó 5+5
40.005131.00		8MM Ó 4+4

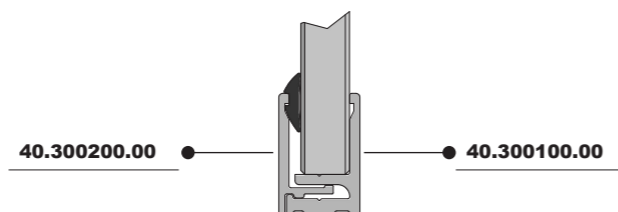
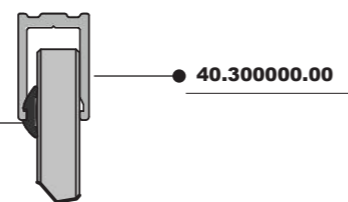

.2 MONTAJE
ASSEMBLY

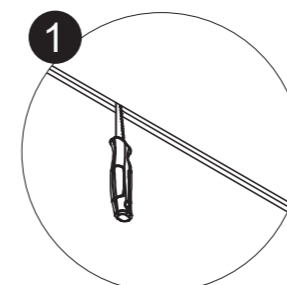

1 PARA LA COLOCACION DE LA "U" ULED DEBEMOS MARCAR LA ZONA DONDE VA UBICADO EL PERFIL Y CORTAREMOS EL PLADUR CON LA HERRAMIENTA INDICADA.

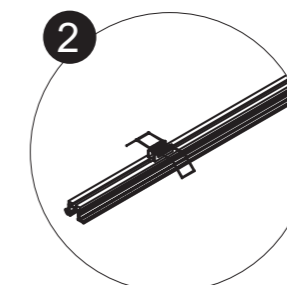

2 SEGUIDAMENTE CORTAREMOS A MEDIDA LA "U" E INTRODUCIREMOS LOS SOPORTES.

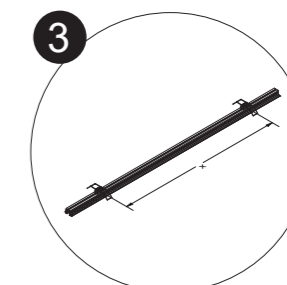

3 LA COLOCACION DE LOS SOPORTES LA REALIZAREMOS EN LOS EXTREMOS ENTRE 50 Y 200 MM Y SEPARADO ENTRE SI UN MAX DE 800 MM.

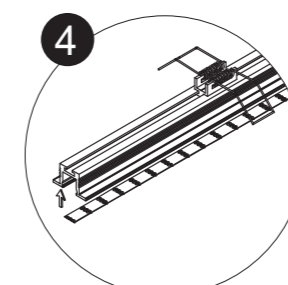

4 UNA VEZ COLOCADOS LOS SOPORTES REALIZAREMOS LA INSTALACION DEL LED SI PROCEDE Y SITUAREMOS LA U EN EL LUGAR DESTINADO A SU COLOCACION.

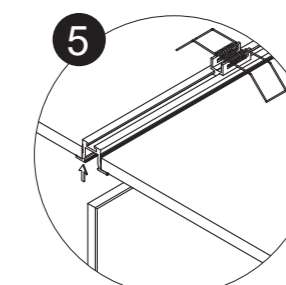

5 FINALMENTE INSTALAREMOS EL VIDRIO.



ESTE SISTEMA LE PERMITE LA COLOCACION DE LOS PERFILES ULED SIN NECESIDAD DE PONER NINGUN TIPO DE SOPORTE.

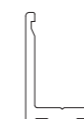
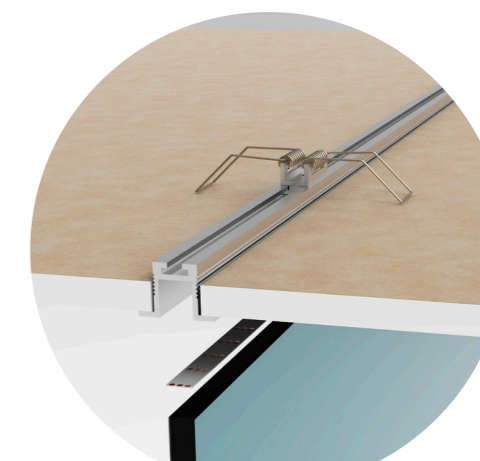

30x20 MM INT 26X15MM



30x20 MM INT 20X15MM



23x15 MM INT 20X10.5MM



15x14 MM INT 13X8.5MM

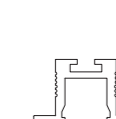

20x33 MM INT 14X13.5MM